



ORTHODONTICS  
KIEFERORTHOPÄDIE  
2021

**LEIBINGER**  
DENTAL.





### EXPERIENCE IN QUALITY

OTTO LEIBINGER GmbH was established in 1978. Its founder and namesake comes from a family with a long tradition in instrument manufacture. Our location in Mühlheim near Tuttlingen provides the best conditions for manufacturing high-quality dental hand instruments as the world's centre for medical technology.

In collaborating with us, customers greatly appreciate our flexibility and service strengths. With direct, personal care and a solution-oriented way of thinking and handling, we set the course for a long-term, cooperative partnership.

Our extensive array of products ranges from dental hand instruments currently in use, such as instruments for fillings and periodontal treatment, through to instruments for dental surgery and dental technology laboratories. We offer everything from one source. All products manufactured by ourselves or from selected suppliers undergo systematic and stringent quality control. This is how we guarantee for the consistent high quality of every single instrument supplied by OTTO LEIBINGER.

### MIT QUALITÄT KENNEN WIR UNS AUS

Die OTTO LEIBINGER GmbH besteht seit 1978. Ihr Gründer und Namensgeber stammt aus einer Familie, in der die Instrumentenherstellung eine lange Tradition hat. Auch unser Standort, Mühlheim bei Tuttlingen, bringt als Weltzentrum der Medizintechnik beste Voraussetzungen für die Herstellung von hochwertigen Dental-Handinstrumenten mit sich.

In der Zusammenarbeit wissen Kunden unsere Flexibilität und Servicestärke zu schätzen. Mit persönlicher Betreuung, kurzen Wegen und einem lösungsorientierten Denken und Handeln stellen wir die Weichen für ein langfristiges, partnerschaftliches Miteinander.

Unser umfangreiches Programm reicht weit über die gängigen dentalen Handinstrumente und Instrumente für die dentale Chirurgie bzw. das Zahntechnik-Labor hinaus. Wir bieten alles aus einer Hand. Sowohl die Produkte aus eigener Herstellung als auch die von ausgewählten Lieferanten zugekauften Teile unterliegen konsequent unseren strengen Kontrollen und Prüfverfahren. So wird die gleichbleibend hohe Qualität gesichert, die jedes einzelne Instrument aus dem Hause OTTO LEIBINGER auszeichnet.





- 6 INDEX INDEX
- 7 WARRANTY INFORMATION GARANTIE INFO
- 8 - 11 DISTAL CUTTER, WIRE CUTTERS  
DISTALSCHNEIDER, DRAHTSCHNEIDEZANGEN
- 12 - 13 ALIGNER PLIERS ALIGNER ZANGEN
- 14 - 17 WIRE BENDING PLIERS DRAHTBIEGEZANGEN
- 18 WEINGART UNIVERSAL PLIERS  
WEINGART UNIVERSALZANGEN
- 19 THREE-FINGER-PLIERS DREIFINGERZANGEN
- 20 - 26 WIRE BENDING PLIERS DRAHTBIEGEZANGEN
- 27 LIGATURE FORCEPS, SEPARATING FORCEPS  
LIGATURZANGEN, SEPARIERZANGEN
- 28 MOSQUITO FORCEPS, SCISSORS  
MOSQUITO ZANGEN, SCHEREN
- 29 INSTRUMENT OIL INSTRUMENTENÖL
- 30 - 31 LIGATURE INSTRUMENTS LIGATUR INSTRUMENTE
- 32 ORTHODONTIC TWEEZERS KFO-PINZETTEN
- 33 MEASURING INSTRUMENTS MESSINSTRUMENTE
- 34 - 35 RACKS & TRAYS STÄNDER & TRAYS
- 36 - 37 TECHNICAL PLIERS  
TECHNISCHE ZANGEN

ART.-NR.	PAGE/SEITE				
103/3	31	630/2	37	630/69	19
103/3L	27	630/3	37	630/6HS	23
103/3R	27	630/34	37	630/71	18
119/10	30	630/3TC	37	630/72TC	18
119/11	30	630/20	14	630/73HS	25
119/13	30	630/20D	14	630/74	25
119/15	30	630/20TC	14	630/75	23
119/16	30	630/21TC	14	630/76	23
119/17	30	630/22	19	630/81	12
119/18	31	630/23	19	630/82	12
119/24	30	630/24	19	630/83	13
119/25	30	630/25	22	630/84	13
175/2	27	630/26	22	630/SP1	24
175/20	27	630/29	18	630/SP12	24
175/21	27	630/29S	18	630/SP34	24
175/23	27	630/29SD	18	631/3	36
175/2TC	27	630/31	20	631/4	36
175/3	27	630/32	20	631/5	36
175/3TC	27	630/33	37	632/15TC	11
210/1	28	630/35	16	632/16TC	9
210/2	28	630/36	22	632/17TC	9
215/31	33	630/37	23	632/18TC	9
215/32	33	630/38	16	632/19TC	8
215/33	33	630/39	24	632/1TC	8
250/5	28	630/4	14	632/2TC	8
250/5TC	28	630/41	27	632/20TC	9
290/1	28	630/42	9	632/24TC	9
290/14	28	630/43	9	632/3TC	10
290/15	28	630/44	15	632/4TC	11
290/2	28	630/45	16	632/5TC	11
291/11	28	630/46	16	632/6	10
291/14	28	630/47	15	632/6TC	10
291/21	28	630/48	25	632/8TC	10
291/24	28	630/4TC	14	632/9TC	8
500/21	35	630/50TC	26	633/1	32
500/22	35	630/51	23	633/2	32
500/23	35	630/52	17	633/3	32
630/10	37	630/53	17	633/4	32
630/11	14	630/56	23	633/5	32
630/12	22	630/58	17	633/6	32
630/13	22	630/59	21	634/018	33
630/15	26	630/6	23	634/022	33
630/17	26	630/60	21	634/1	31
630/18	20	630/61	21	900/8	34
630/18E	20	630/62	20	900/HTO7	29
630/18TC	20	630/63	26	Ortho Basic Set	34
630/19	15	630/64	22		

## WARRANTY INFORMATION

The orthodontic instruments of Otto Leibinger GmbH carry a lifetime warranty against the defects of material and workmanship. Like all manufacturers of orthodontic products, „Lifetime“ means, the normal lifespan of the instruments. The warranty covers breakages, joint failures or hinges and corrosion under normal usage. Thereby, appropriate cleaning and maintenance is a prerequisite. This warranty is void if the instruments are improperly used, including cleaning, processing and lubrication. Otto Leibinger GmbH reserves the right to decide whether an instrument is to be repaired or replaced. Sharpening the cutters from one year after purchasing and repairing minor tip damages is considered routine maintenance and is not covered by warranty. In order to protect the tip of your cutter from fractures, we recommend you, if feasible, not to cut the wires with the foremost third of the cutting edge.

### Important – to make sure you can use your ortho plier properly for a long time

- Please only cut wires up to the **maximum thickness** indicated on the pliers itself or also mentioned in our latest orthodontic catalogue.
- Don't cut the wire with the very tip of the pliers, keep some distance of **1-2mm** from the very tip.
- It is also important to remove the residue of wire from the cutting edges as even the small pieces may stuck inside the jaw and can be the reason of breakage during next cut.
- Don't twist the wire while cutting, always try to do a straight and even cut.



Our pliers are of high quality and made out of the best material. However, there might appear some wear off due to constant use. In this case we are pleased to offer our re-sharpening service.

## GARANTIE INFORMATION

Die kieferorthopädischen Instrumente von Otto Leibinger GmbH verfügen über eine lebenslange Garantie auf Material- und Verarbeitungsfehler. „Lebenslang“ bedeutet in diesem Fall, wie bei allen Herstellern kieferorthopädischer Produkte, die normale Gebrauchsdauer der Instrumente. Die Garantie deckt Brüche, Versagen der Scharniere bzw. Gelenke und Korrosion bei normalem Gebrauch ab. Dabei wird eine sachgemäße Reinigung und Pflege vorausgesetzt. Bei unsachgemäßer Verwendung der Instrumente, einschließlich Reinigung, Aufbereitung und Schmierung, kann die Garantie erlöschen. Otto Leibinger GmbH behält sich die Entscheidung darüber vor, ob ein Instrument repariert oder ersetzt wird. Das Schärfen von Cuttern ab einem Jahr nach dem Kauf und die Behebung kleinerer Schäden an den Zangenspitzen gilt als routinemäßige Wartung im Rahmen des normalen Gebrauchs und wird nicht von der Garantie abgedeckt. Um die Spitzen Ihrer Cutter vor Frakturen zu bewahren, empfehlen wir, wenn machbar, Drähte nicht mit dem vordersten Drittel der Schneidekante zu durchtrennen.

### Wichtig – So haben Sie lange Freude an Ihren KFO-Zangen

- Bitte beachten Sie die Hinweise zur **maximalen Drahtstärke**, die für die jeweilige Zange verwendet werden darf. Dies ist entweder auf der Zange direkt oder auch im aktuellen Katalog angegeben.
- Schneiden Sie die Drähte nicht direkt mit dem vorderen Teil der Spitze, sondern mit ca. **1-2mm Abstand** zur Spitze.
- Es ist wichtig, Drahrückstände auf den Schneiden immer gleich zu entfernen, so dass diese nicht bei der nächsten Anwendung in das Material eingedrückt werden.
- Den Draht bei Schneiden nicht abdrehen, sondern glatt durchschneiden.



Unsere Zangen sind qualitativ sehr hochwertig und aus den besten Materialien gefertigt. Dennoch kann es mit der Zeit zu Abnutzungen kommen. Hier bieten wir Ihnen gerne unseren Nachschleif-Service an.

# WIRE CUTTERS

## DRAHTSCHNEIDEZANGEN

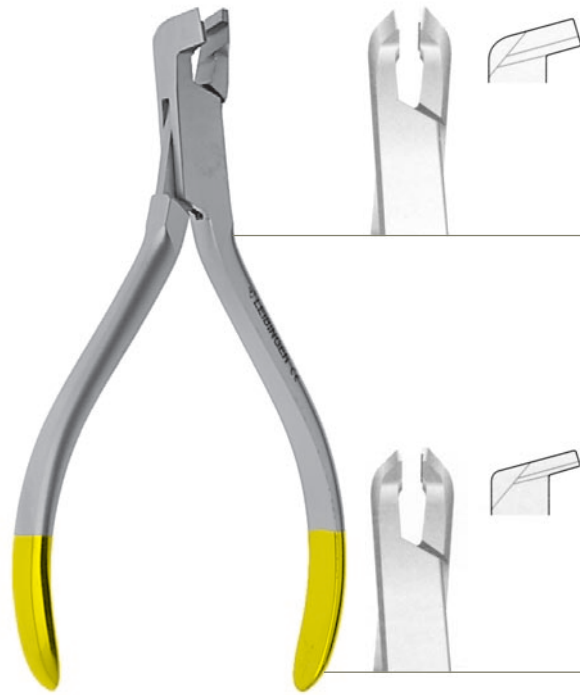

Distal End Cutter  
with safety hold

Distalschneider  
mit Drahtfangvorrichtung

○ Ø 0,35mm / .014"

□ 0.55x0.64mm / .021"x.025"

[ 125mm

632/1 **TC**

○ Ø 0.35mm / .014"

□ 0.55x0.64mm / .021x.025"

[ 125mm

632/2 **TC**

○ Ø 0.35mm / .014"

□ 0.55x0.64mm / .021x.025"

[ 150mm

632/9 **TC**



Mini Distal End Cutter TC

Mini Distal End Cutter TC

□ 0,41 x 0,56mm (.016 x .022)

⊗ .017 x.025

[ 125mm

632/19 **TC**





Distal End Cutter  
with safety hold  
Distalschneider  
mit Drahfangvorrichtung  
⌘ Max. Ø 0.4mm / .016"  
[ 150mm  
632/16 TC

○ Ø 0,35mm / .014"  
□ 0.55x0.64mm / .021"x.025  
[ 150mm  
632/17 TC

○ Ø 0,35mm / .014"  
□ 0.55x0.64mm / .021"x.025  
[ 130mm  
632/18 TC

Rounded cutter head to ensure  
pleasant treatment for the patient  
and easier access for the user  
to difficult to reach areas

Abgerundetes Arbeitsende,  
angenehm für den Patienten und  
ideal für den Anwender im  
Bereich der hinteren Molaren



FLUSH CUTTER  
FLUSH CUTTER  
□ 0.55x0.64mm / .021x.025"  
○ 0,4mm / .016"  
[ 130mm  
632/20 TC

To cut flush to the bracket  
or buccal tube

Bündiges Schneiden zum Bracket  
oder Bukkalröhrchen

□ 0.41x0.55mm / .016x.021"  
○ 0,3mm / .012"  
[ 130mm  
632/24 TC



Ligature Cutter  
Ligatur Cutter  
○ Max. Ø 0.7mm / .028"  
[ 120mm  
632/3 TC



Mini Ligature Cutter  
Mini Ligaturen  
Schneidezange  
○ Max. Ø 0,3mm / .012"  
[ 120mm  
632/8 TC



ANGLE  
Wire Cutter  
Drahtschneidezange  
○ Max. Ø 0,3mm / .012"  
[ 130mm  
632/6 TC  
without TC  
ohne TC  
○ Max. Ø 0,3mm / .012"  
632/6



Wire Cutting Forceps  
Drahtschneidezange  
Ø 0,3mm / .014"  
[ 130mm  
632/15 TC



Head Cutter for  
hard wire  
Kopfschneider  
für harten Draht  
Ø Max. Ø 1,0mm / .040"  
[ 145mm  
632/4 TC



Side Cutter  
for hard wire  
Seitenschneider  
für harten Draht  
Ø Max. Ø 1,0mm / .040"  
[ 150mm  
632/5 TC

NEW

ALIGNER PLIERS

ALIGNER ZANGEN



THE HORIZONTAL:  
pliers enables to  
horizontally correct with  
no punching  
erzeugt eine horizontale  
Vertiefung ohne  
Ausstanzung  
[ 120mm  
630/81



THE VERTICAL:  
pliers enables to vertically  
correct with no punching  
erzeugt eine vertikale  
Vertiefung ohne  
Ausstanzung  
[ 120mm  
630/82



THE HOLE PUNCH:  
pliers produces half moon  
shape to allow  
attachments to be placed  
zur Ausstanzung  
halbmondförmiger  
Ausparungen um Platz  
für Attachments zu schaffen  
[ 120mm  
630/83



THE TEAR DROP:  
creates a notch in an area  
where hooks are required  
zum Ausstanzen einer  
Einkerbung am gingivalen  
Rand des Aligners  
[ 120mm  
630/84



ANGLE  
Wire Bending Pliers  
Drahtbiegezange  
○ Max. Ø 0,7mm / .028"  
[ 125mm  
630/4  
630/4 **TC**



ANGLE  
Wire Bending Pliers, round  
Drahtbiegezange, rund  
○ Max. Ø 0,7mm / .028"  
[ 125mm  
630/11



ADAMS  
Wire Bending Pliers  
Drahtbiegezange  
○ Max. Ø 0,7mm / .028"  
[ 125mm  
630/20

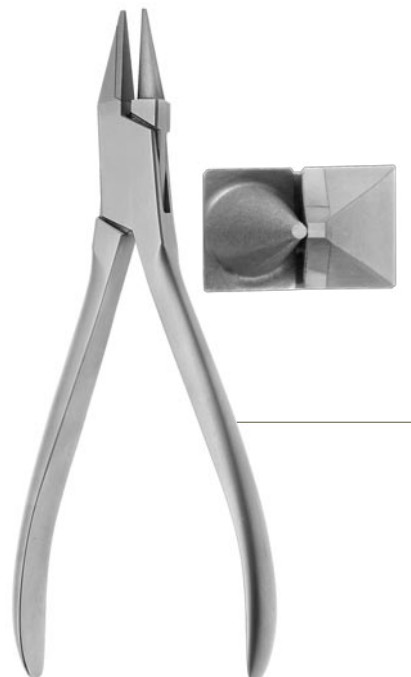

ADAMS  
Wire and Arch bending pliers  
No. 65  
Draht- und Bogenbiegezange  
No.65  
[ 150mm  
630/21 **TC**



JARABAC  
Wire bending pliers  
Drahtbiegezange  
○ Max. Ø 0,7mm / .028"  
[ 140mm  
630/19



Wire Bending Pliers  
Drahtbiegezange  
○ Max. Ø 0,5mm / .020"  
[ 130mm  
630/44



Wire Bending Pliers  
with grooves  
Drahtbiegezange  
mit Führungsrillen  
○ Max. Ø 0,7mm / .028"  
[ 135mm  
630/47



**YOUNG**  
Loop and Arch Forming Pliers  
Schlaufen- und  
Bogenbiegezeuge  
○ Ø 0,7mm / .028"  
[ 130mm  
630/35



**TWEED**  
Loop and Arch Forming Pliers  
Schlaufen- und  
Bogenbiegezeuge  
○ Ø 0,5mm / .020"  
[ 135mm  
630/38

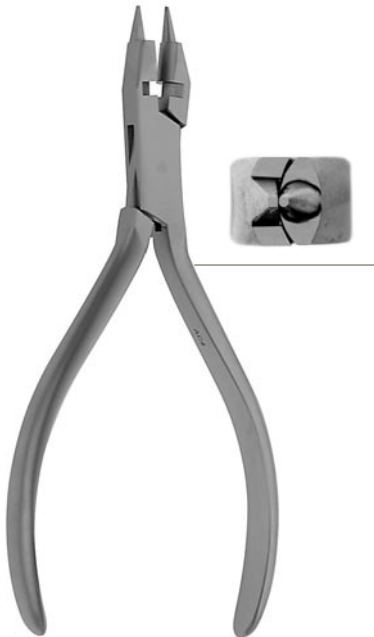

Lightwire Bird Beak Pliers  
with Cutter  
Lightwire Bird Beak Zange  
mit Cutter  
○ Max. Ø 0,6mm / .024"  
[ 135mm  
630/45



Lightwire Loop Forming Pliers  
with Cutter  
Lightwire Loop Biegezeuge  
mit Cutter  
○ Max. Ø 0,4mm / .016"  
[ 135mm  
630/46



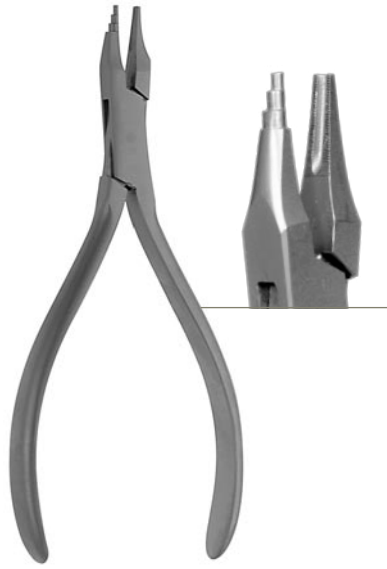

TWEED  
Loop and Arch Forming Pliers  
Schlaufen- und  
Bogenbiegezeuge  
○ Ø 0,5mm / .020"  
[ 135mm  
630/52



TWEED  
Loop and Arch Forming Pliers  
Schlaufen- und  
Bogenbiegezeuge  
○ Ø 0,5mm / .020"  
[ 140mm  
630/53



TWEED  
Loop and Arch Forming Pliers  
Schlaufen- und  
Bogenbiegezeuge  
○ Ø 0,7mm / .028"  
[ 140mm  
630/58

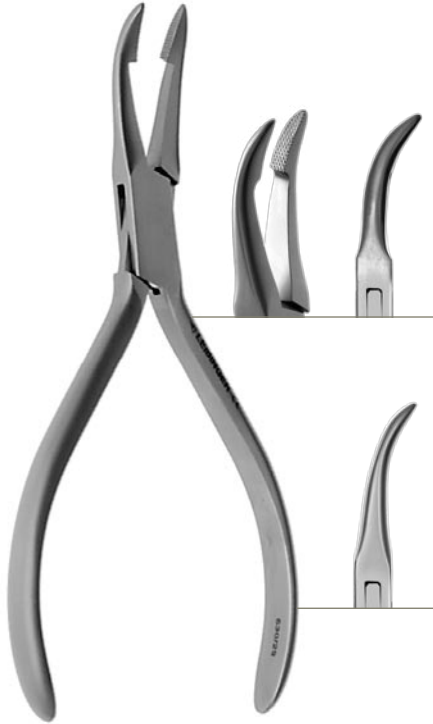

WEINGART  
Universal Pliers  
Universalzange  
Ø 0,7mm / .028"  
[ 145mm  
630/29

WEINGART DELICATE  
Universal Pliers  
delicate pattern  
Universalzange grazil  
Ø 0,7mm / .028"  
[ 140mm  
630/29S

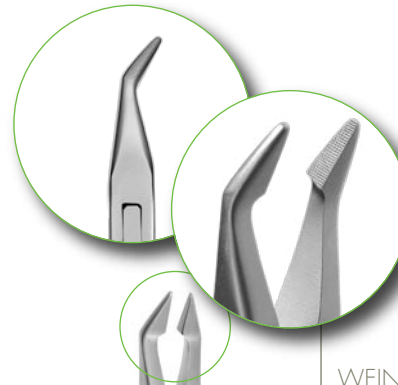

Better  
transmission  
of force  
because  
of the short jaws.  
Bessere  
Kraftübertragung  
durch  
kurzes Maul.



WEINGART  
Universal pliers  
with short jaws  
Universal Zange  
mit kurzem Arbeitsende  
Ø 0,5mm / .020"  
[ 140mm  
630/71



WEINGART ULTRASLIM  
Universal pliers  
ultraslim jaws  
Universal Zange  
ultrafeines Arbeitsende  
Ø 0,5mm / .020"  
[ 145mm  
630/29SD



WEINGART DELICATE  
universal pliers  
delicate  
Universal Zange  
grazil  
Ø 0,5mm / .020"  
[ 145mm  
630/72 TC



ADERER  
Three-Finger-Pliers  
Dreifingerzange  
○ Ø 0,7mm / .028"  
[ 125mm  
630/22



ADERER  
Three-Finger-Pliers  
strong pattern  
Dreifingerzange  
kräftiges Modell  
○ Max. Ø 0,9mm / .028"  
[ 125mm  
630/23



ADERER  
Three-Finger-Pliers  
Dreifingerzange  
○ Max. Ø 0,5mm / .020"  
[ 115mm  
630/24



ADERER  
Three Finger Pliers  
Dreifingerzange  
○ Ø 0,3mm / .012"  
[ 125mm  
630/69



HOW  
Ligature Pliers  
straight  
Ligaturenzange  
gerade  
[ 145mm  
630/31

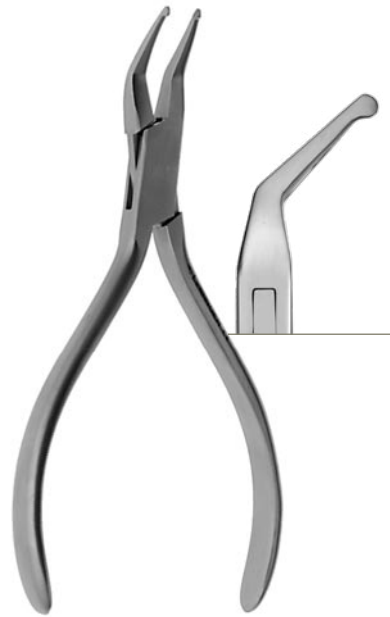

HOW  
Ligature Pliers  
45° angled  
Ligaturenzange  
45° abgewinkelt  
[ 140mm  
630/32



ADERER  
Band Removing Pliers  
Bandabnehmezange  
[ 135mm  
630/18  
630/18 **TC**

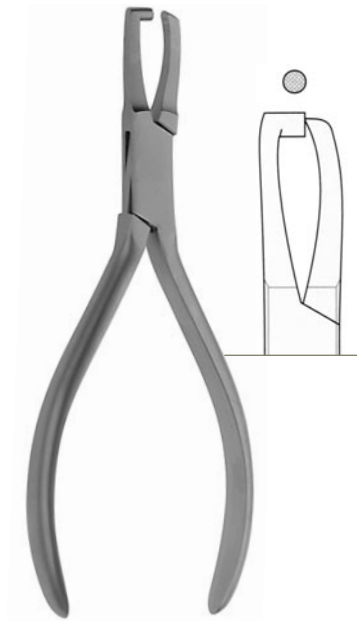

OLIVER  
Band Removing Pliers  
Bandabnehmezange  
[ 140mm  
630/62

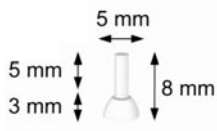

Replacement Tip for 630/18  
with thread

Ersatz-Plastikschutzkappe für 630/18  
mit Gewinde

630/18E



Bracket Removing Pliers  
Bracket-Abnehmezange  
[ 135mm  
630/60



Bracket Removing Pliers  
angled 45°  
Bracket-Abnehmezange  
45° abgewinkelt  
[ 135mm  
630/61



Removing Pliers  
Abnehmezange  
[ 125mm  
630/59



SCHWARZ  
Hollow Chop Pliers  
Hohlkehlzange  
Ø 0,7mm / .028"  
[ 125mm  
630/12



3mm



JOHNSON  
Contouring Pliers  
Konturenzange  
[ 135mm  
630/64



SCHWARZ  
Hollow Chop Pliers  
Hohlkehlzange  
Ø 0,7mm / .028"  
[ 140mm  
630/13



4mm



JOHNSON  
Contouring Pliers  
Konturenzange  
[ 135mm  
630/25



ANDERSEN  
Hollow Chop Pliers  
Hohlkehlzange  
[ 130mm  
630/36



GORDON  
Contouring Pliers  
Konturenzange  
[ 135mm  
630/26



DeLa ROSA  
Arch Contouring Pliers  
with groove guides  
DeLa ROSA  
Konturenzange mit Führungsrillen  
[ 125mm  
630/37



Arch Contouring Pliers  
Konturenzange  
[ 125mm  
630/56



Lingual Arch Forming Plier  
Bügelbiegezange  
○ Ø 0,7mm / .028"  
[ 125mm  
630/51



ANGLE / TWEED  
Arch Forming Pliers  
Bogen- und Torque-Zange  
○ Ø 0,5mm / .028"  
[ 125mm  
630/6

Arch Forming Pliers  
special Hard Steel Tips  
Bogen- und Torque-Zange  
Arbeitsenden aus speziellem Hartstahl  
○ Ø 0,5mm / .028"  
[ 125mm  
630/6HS



630/76

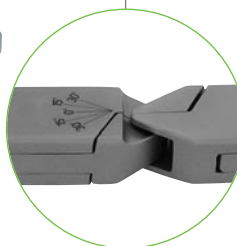

Torquing Pliers (Set)  
Set of pliers used to place a torque  
to square/rectangular archwire  
Torque Zangen (Set)  
Set bestehend aus 2 Zangen zum Einbringen  
von Einzelzahn-Torque in Vierkantbögen  
□ 0.55x0.64mm / .021"x.025"  
[ 140mm  
630/75 + 630/76

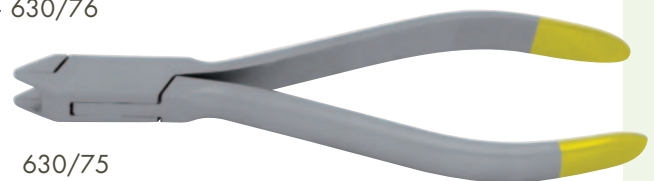

630/75

STEP BENDING PLIERS  
STUFENBIEGEZANGEN



Step Pliers  
Stufenbiegezeuge

[ 135mm

1/2mm

630/SP12

3/4mm

630/SP34

1mm

630/SP1

These Step Bending Pliers allow the treating dentist or team member to put precise bends in NiTi wires that lead to the desired tooth movements. The pliers make things easy! With these pliers, bracket repositioning is no longer the only way to make changes during treatment. These pliers make bracket repositioning unnecessary in the majority of circumstances.

Diese Stufenbiegezeugen erlauben dem behandelnden Zahnarzt oder Teammitglied, in NiTi-Drähte präzise Biegungen einzuarbeiten, die zu den gewünschten Zahnbewegungen führen. Die Zangen machen die Sache einfach. Mit diesen Zangen ist die Repositionierung von Brackets nicht mehr die einzige Möglichkeit, während der Behandlung Änderungen vorzunehmen. Diese Zangen machen die Repositionierung von Brackets in den meisten Fällen überflüssig.



NANCE

step loop  
bending pliers  
steps of 3, 4, 5  
and 6mm  
enable exact and  
even bending

Stufenbiegezeuge  
Stufen von 3, 4, 5  
und 6mm  
ermöglichen ein  
exaktes und  
gleichmäßiges  
Biegen

[ 130mm

630/39





V-Step Pliers  
places V-bends in arch wires  
130mm  
for wire up to .021 x .025"

V-Step Zange  
zum Formen von V-Biegungen  
130mm  
für Draht bis max. .021 x .025"  
**630/48**



Crimpable Arch  
Wire Hook Pliers  
for surgical ball hooks  
straight, 140mm  
Kugel Haken Setzzange  
gerade 140mm  
**630/73HS**



Hammerhead Pliers  
for bending nickel-titanium  
arches/wires  
in the molar region  
Hammerhead Zange  
zum Umbiegen von  
Nickel-Titan-Bögen/-Drähten  
im Molarenbereich  
Ø .018"  
[ 140mm  
**630/74**



NANCE  
Arrow Clasp Forming Pliers  
Pfeilformzange  
O Max. Ø 0,7mm / .028"  
[ 125mm  
630/15



ADAMS-NANCE  
Clasp Bending Pliers  
for Adams Claps  
Klammernbiegezeuge  
für Adams Klammern  
O Max. Ø 0,7mm / .028"  
[ 155mm  
630/17



SCHWARZ  
Arrow Clasp Forming Pliers  
Pfeilformzange  
O Max. Ø 0,7mm / .028"  
[ 130mm  
630/63



KÖHLER  
Wire Bending Pliers  
Drahtbiegezeuge  
[ 125mm  
630/50 TC



SMAHA Ligature Forceps  
SMAHA Ligaturenzange  
[ 140mm  
175/20

slim and delicate  
working tips – easier  
access especially in  
narrow, limited situations  
Grazile Arbeitsspitzen –  
ideal bei geringem  
Bracketabstand

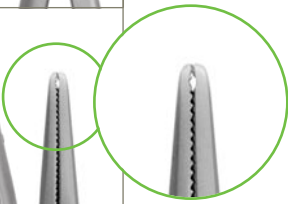

SMAHA Ligature Forceps  
delicate tips with groove  
SMAHA Ligaturenzange  
feines Arbeitssende  
mit Halterille  
[ 140mm  
175/21



MATHIEU Ligature Forceps  
5mm serration length  
MATHIEU Ligaturenzange  
5mm Zahnung  
[ 140mm  
175/23



MATHIEU Standard  
[ 140mm  
175/3  
175/3 TC



[ 170mm  
175/2  
175/2 TC



Separating Forceps  
for inserting elastic  
separators  
Separierzange  
zum Einbringen  
von Gummi-  
Separierligaturen  
[ 155mm  
630/41



☺  
1:2 Teeth  
1:2 Zähne

HALSTEAD MOSQUITO

straight

gerade

[ 12 cm

290/1

291/11 ☺

[ 14 cm

290/14

291/14 ☺



HALSTEAD MOSQUITO

curved

gebogen

[ 12 cm

290/2

291/21 ☺

[ 14 cm

290/15

291/24 ☺



BEEBEE

straight

gerade

[ 10,5 cm

210/1

curved

gebogen

[ 10,5 cm

210/2

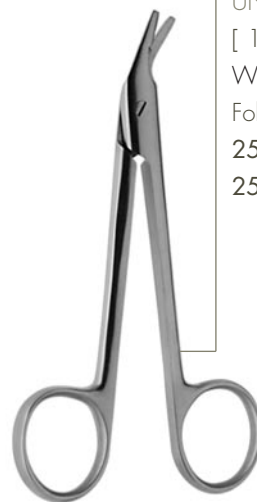

UNIVERSAL

[ 12cm

Wire Scissors

Folien-/Draht- & Blehschere

250/5

250/5 TC

# HI TECH ÖL HI TECH OIL

## HI TECH OIL – sterilizable

Lubricant for dental and surgical instruments

- Validated for autoclave and heat sterilization
- Heat resistant up to 260°C
- Excellent protection against corrosion and oxidation
- Odorless, transparent and silicone free
- No staining and crusting on instruments
- Application tip 7mm

## HI TECH ÖL – sterilisierbar

Zur Pflege von Dental- und Chirurgie-Instrumenten

- Validiert für Autoklav und Heißluftsterilisation
- Temperaturstabil bis 260°C
- Ausgezeichneter Korrosions- und Oxidationsschutz für Ihre Instrumente
- Geruchlos, transparent und silikonfrei
- Keine Fleckenbildung und kein Verharzen auf den Instrumenten
- Mit praktischer Dosiernadel in 7mm



with 7mm application tip  
mit 7mm Applikationsnadel  
900/HTO7

GOOD  
MAINTENANCE  
>>  
LONG PRODUCT LIFE

GUTE PFLEGE  
>>  
LANGE PRODUKT-  
LEBENSDAUER.



MERSHON  
Band Pusher  
Bandandrücker  
119/13



D.S. Band Seater  
D.S. Bandaufsetzer  
119/10



Scaler / Band Pusher, handle Ø 6mm solid  
Reiniger / Bandstopfer, Griff Ø 6mm massiv  
119/25



Scaler / Band Pusher, handle Ø 8mm solid  
Reiniger / Bandstopfer, Griff Ø 8mm massiv  
119/17



Ligature Instrument d.e., handle Ø 6mm solid  
Ligaturinstrument d.e., Griff Ø 6mm massiv  
119/15



Ligature Instrument d.e., handle Ø 8mm solid  
Ligaturinstrument d.e., Griff Ø 8mm massiv  
119/16



Ligature Tucker  
Ligaturadapter  
119/11



Ligature Tucker  
Ligaturadapter  
119/24

### EXPLORERS

To remove ligatures and adjust the brackets.  
All explorers are with ERGODESIGN handle and fine but unbreakable tips.

### SONDEN

Geeignet zum Entfernen von Ligaturen und zum Justieren von Brackets.  
Alle Sonden mit ERGODESIGN Griff und feinen aber unzerbrechlichen Spitzen.



FIG. 3  
short tip  
kurze Spitze  
103/3



Explorer / Ligature Instrument, handle Ø 6mm solid  
universal instrument for placing bands and to remove cement scraps  
Sonde / Ligaturinstrument, Griff Ø 6mm massiv  
universelles Instrument zum Platzieren von Bändern und zum Beseitigen von Zementresten  
119/18



BERNKLAU  
Overbite Ruler  
Messlehre  
634/1

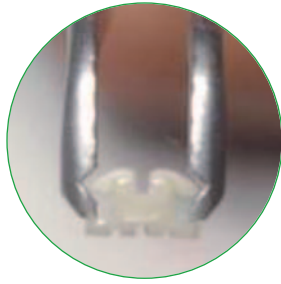
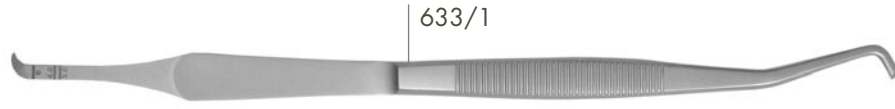

Grasping brackets  
Fassen der Brackets



Positioning brackets  
Positionieren der Brackets



Adjusting brackets  
Ausrichten der Brackets



633/2



633/3



633/4



633/5



633/6



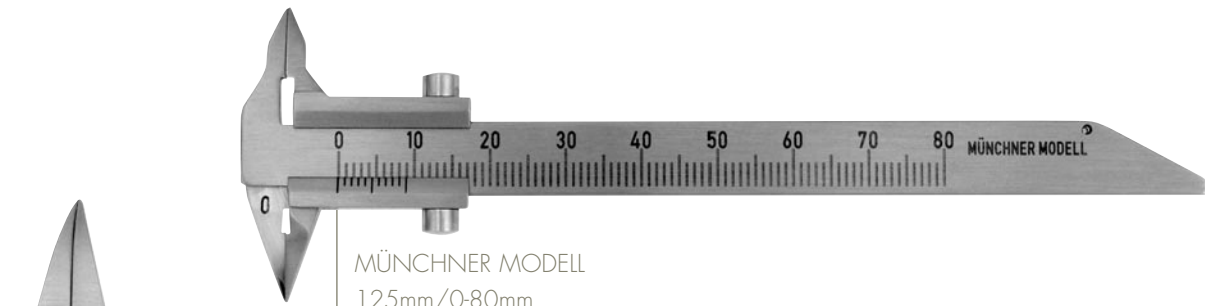

MÜNCHNER MODELL  
125mm/0-80mm  
215/31



BEERENDONK  
125mm/0-80mm  
215/32

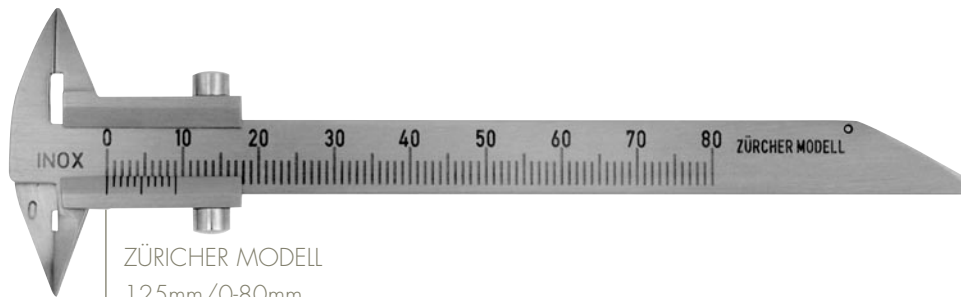

ZÜRCHER MODELL  
125mm/0-80mm  
215/33

#### BRACKET POSITIONING GAUGE

New positioning gauge with a special fine tip, enables the precise positioning of brackets and with the correct distance between bracket slot and incisal edge. For heights of 3,5mm, 4mm, 4,5mm and 5mm

#### BRACKETPOSITIONIERER

Das ideale Hilfsmittel für die einfache und exakte Positionierung der Brackets mit korrektem Abstand zur Schneidekante. Für Höhen von 3,5mm, 4mm, 4,5mm und 5mm.



for .018 slot brackets  
für .018 Slot Brackets  
634/018 1/1



for .022 slot brackets  
für .022 Slot Brackets  
634/022 1/1

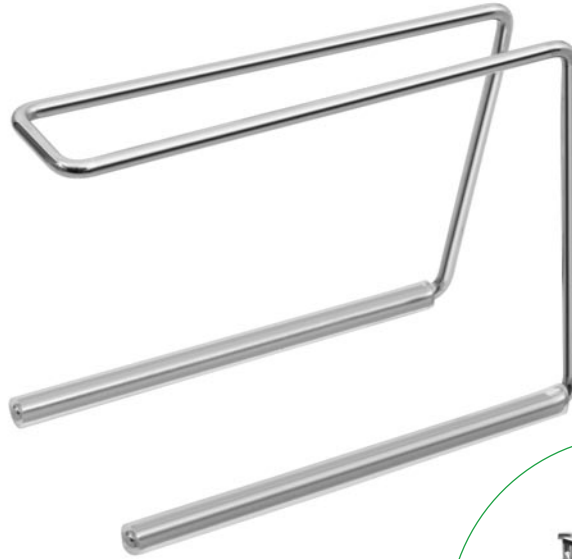

Plier Rack  
stainless steel  
with non slip silicone feet  
Zangenständer  
Edelstahl  
mit rutschfesten Silikonfüßen  
900/8

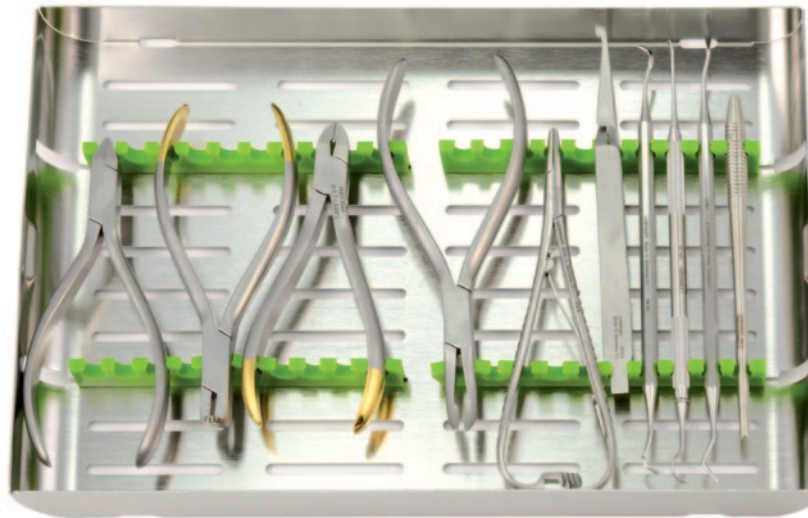
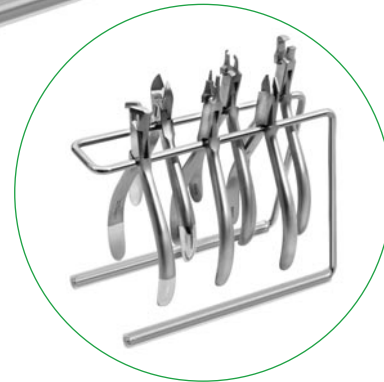

### ORTHO BASIC SET

### KFO BASIS SET

630/20	ADAMS Wire Bending Pliers No.64	ADAMS Drahtbiegezange No.64
632/3TC	TC Ligature Cutter for wire up to 0,7mm	TC Ligaturschneider für Draht bis 0,7mm
632/2TC	Distal End Cutter TC	TC Distal End Cutter
630/29	Weingart Utility Wire Bending Pliers	Weingart Universal Drahtbiegezange
633/4	Forceps for positioning brackets	Bracketpositionierungs-Pinzette
175/3	Mathieu Needle Holder 14cm	Mathieu Nadelhalter 14cm
119/18	Ligature Tucker / Explorer Fig. 2	Ligaturinstrument / Sonde Fig. 2
200/51	Mirror Handle	Spiegelgriff
119/10	Double sided band seater / remover	Doppelseitiger Bandaufsetzer + Entferner
119/11	Ligature Tucker D/E	Ligaturinstrument d.e.
500/3	Ergo Clip Wash Tray with Silicon Inserts 288 x 187 x 25mm	Wasch Tray mit Silikoneinsätzen 288 x 187 x 25mm

ALSO AVAILABLE  
IN THE  
ORTHO TRAY  
AUCH IM ORTHO TRAY  
ERHÄLTICH

# NEW NEU

# ORTHO TRAY

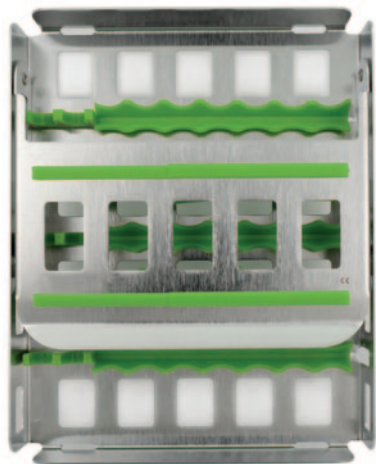

ORTHO TRAY

180 x 140 x 30mm  
500/21

ORTHO TRAY

210 x 180 x 30mm  
500/22

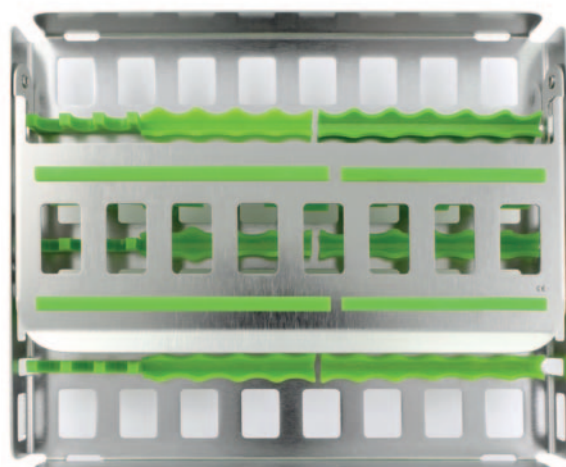

ORTHO TRAY

280 x 180 x 30mm  
500/23





WALDSACHS  
Universal Pliers  
Universalzange  
O Ø 0,7mm / .028"  
[ 150mm  
631/3



Universal Pliers  
Universalzange  
O Ø 1,0mm / .040"  
[ 150mm  
631/4



Universal Pliers  
Universalzange  
O Ø 1,0mm / .040"  
[ 160mm  
631/5



Flat Nose Pliers  
both sides smooth  
Flachzange  
beide Seiten glatt  
[ 140mm  
630/2

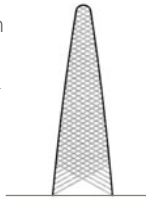

Flat Nose Pliers  
both sides serrated  
Flachzange  
beide Seiten gerieft  
[ 140mm  
630/3

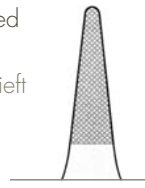

Flat Nose Pliers  
both sides serrated with TC inserts  
Flachzange beide Seiten gerieft  
mit Hartmetalleinsätzen  
[ 140mm  
630/3 **TC**



PEESO  
Wire Bending Pliers  
Drahtbiegezange  
[ 135mm  
630/34

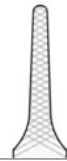

LANGENBECK  
Round Pliers  
Rundzange  
[ 140mm  
630/10



GOSLEE  
Flat Nose Pliers  
Flachzange  
[ 140mm  
630/33

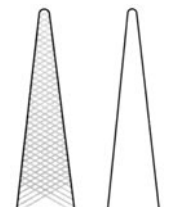



PLEASE FIND OUR FULL RANGE IN THE LATEST  
GENERAL CATALOGUE:

UNSER GESAMTES SORTIMENT FINDEN SIE  
IM AKTUELLEN HAUPTKATALOG:

DIAGNOSTICS DIAGNOSTIK

CONSERVATIVE TREATMENT KONSERVIERENDE BEHANDLUNG

PERIODONTICS PARODONTOLOGIE

EXTRACTION EXTRAKTION

DENTAL SURGERY DENTALE CHIRURGIE

DENTAL ELECTRODES DENTAL-ELEKTRODEN

IMPRESSION TRAYS ABDRUCKLÖFFEL

STORAGE & STERILIZATION AUFBEWAHRUNG & STERILISATION

PROSTHETICS PROTHETIK

IMPLANTOLOGY IMPLANTOLOGIE





**LEIBINGER  
DENTAL.**

GRIESWEG 27, 78570 MÜHLHEIM/GERMANY

FON: +49 (0) 7463-7232

FAX: +49 (0) 7463-222

[info@leibinger-dental.de](mailto:info@leibinger-dental.de)

[www.leibinger-dental.de](http://www.leibinger-dental.de)